

ALBA

с подъемным механизмом

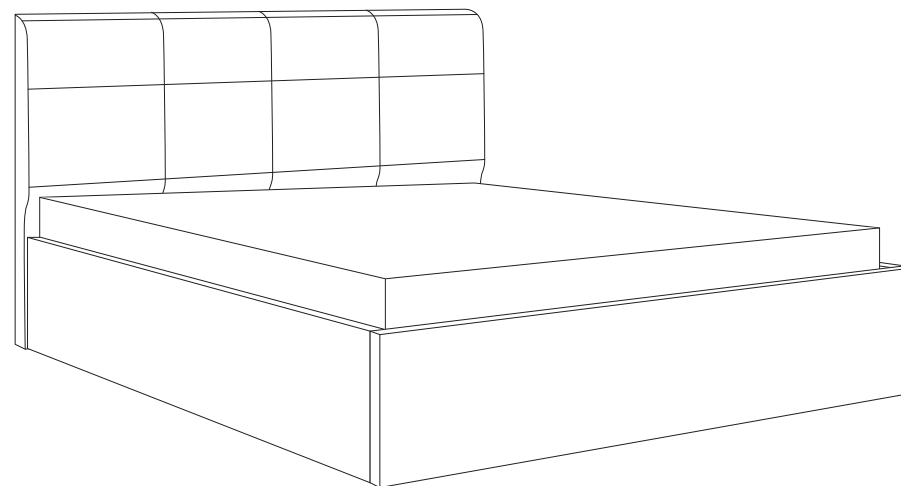

ОРМАТЕК

6

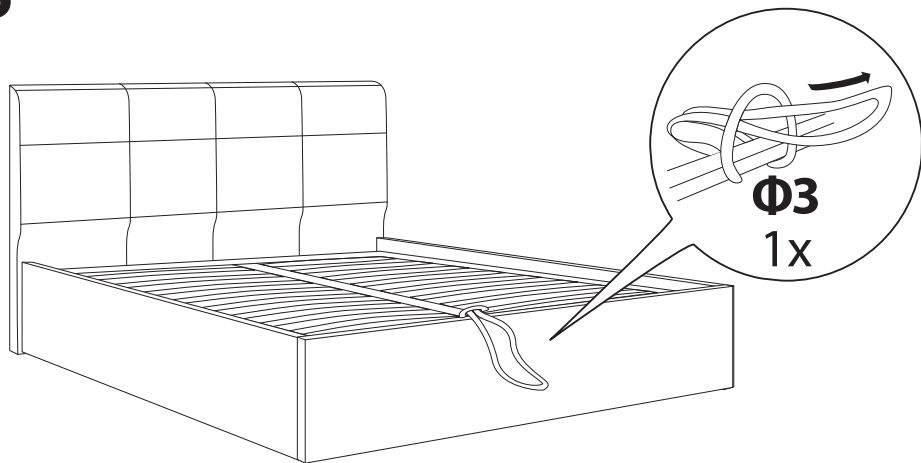

7

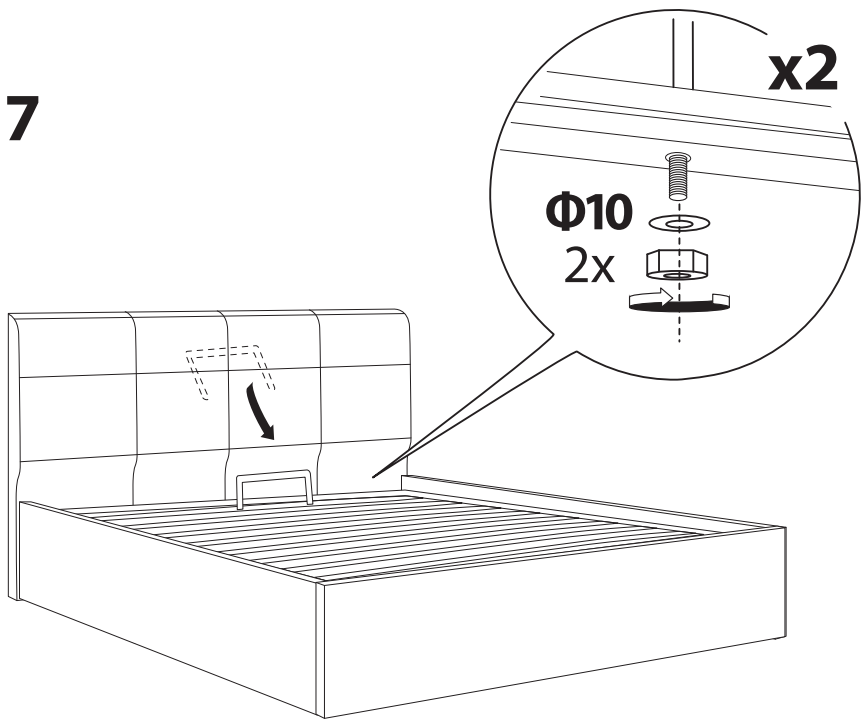

Φ6



4x

Φ7

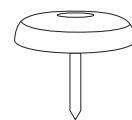

50x

Φ8

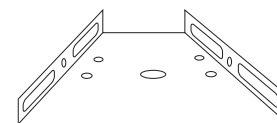

2x

Φ9

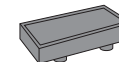

4x

Φ10

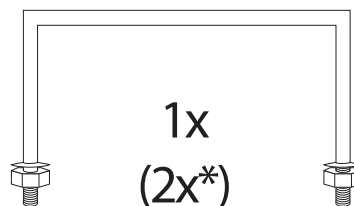

1x
(2x*)

*



1+1

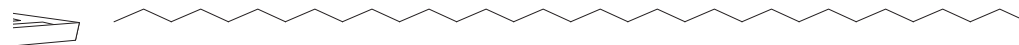

Φ11



M8 4x

Φ12

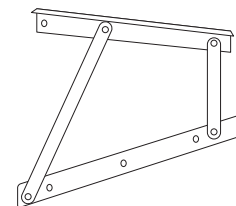

(Л+П) 1x

Φ13

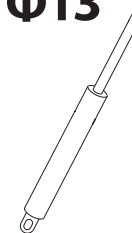

2x

Φ14

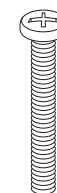

4x

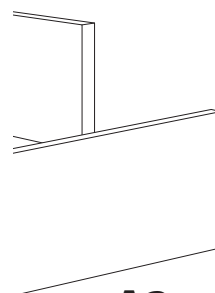

A3

1x

Φ15



8x

Φ16

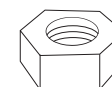

M10 4x

Φ17



4x

